

Wall saddle monoblock medium temperature MOD. IPAM812C ❄️



Included accessories



Table of cooling capacities in W and cold room m³ - MOD. IPAM812C - R455A



AMBIENT T.	5 °C		2 °C		0 °C		-2 °C		-5 °C	
	W	m3	W	m3	W	m3	W	m3	W	m3
25 °C	4974	79,4	4696	68,8	4424	58,3	4157	48,7	3897	39,0
32 °C	4482	67,5	4223	55,8	3970	44,0	3721	38,8	3478	33,6
38 °C	4048	59,2	3806	47,0	3569	34,8	3336	31,8	3107	28,8
43 °C	3679	50,9	3453	40,1	3231	29,3	3013	26,6	2799	24,0

Technical data

Model	IPAM812C
Type	Monoblock (800)
Mounting	Wall
Application	MBP
Expansion	Valve
Defrost	Hot gas
CAT. PED	2
Refrigerant	R455A

Dimensions

Width W	800 mm
Depth D	1154 mm
Height H	800 mm
Net weight	115 kg

Absorption

Power consumption	1560 W
Current consumption	3,9 A

Condenser

Condensation	Air
No. of fan-motors	2
Diameter	300 mm
Air flow	2800 m ³ /h

Evaporator

No. of fan-motors	2
Diameter	300 mm
Air flow	2700 m ³ /h
Air throw	8 m

Compressor

Type	Hermetic
No. of compressors	1 (FH4524P)
Brand	TECUMSEH
Voltage	380-420/3/50
Displacement	43,3 cm ³

Technical features (standard)

- Structure in zinc-plated metal sheet coated with epoxy primer and powder (RAL 9003);
- Easily removable front cover to facilitate both verification and maintenance operations;
- Internal arrangement of components designed to facilitate their maintenance;
- Hermetic compressors with thermal motor protection;
- Heat exchangers with striped copper and aluminium pipes;
- Air condensation;
- Air evaporation;
- Thermostatic valve expansion;
- Programmable hot gas defrosting;
- Heating cable for condensate drain in both MT and LT;
- Stainless steel tray for condensed water evaporation equipped with a copper coil with cataphoresis coating and an overflow exhaust pipe;
- High-pressure safety pressure switch (automatic reset/fixed setting);
- Electronic control unit;
- Programmable electronic board with touch control display;
- Control unit designed for remote management via Wi-Fi module (optional);
- Cold room light with cable L=2,5m;
- Micro-switch with cable L=2,5m;
- Power cable L=2,5m;
- Packaging with wooden pallet and cardboard (included)

Optional a request

- Plug-in kit th. 100 mm without hooks 800 series;
- Plug-in kit th. 60 mm with hooks 800 series;
- Plug-in kit th. 80 mm with hooks 800 series;
- Plug-in kit th. 100 mm with hooks 800 series;
- Plug-in kit th. 120 mm with hooks 800 series;
- Plug-in kit th. 140 mm with hooks 800 series;
- Low-pressure switch (automatic reset/fixed setting);
- Wi-Fi module for remote management;
- Condenser fan speed control with pressure switch;
- Condenser fan speed control with pressure speed variator;
- Compressor crankcase heater;
- Winter kit;
- Remote control panel with cable of 5/10/15/20m;
- Length increase for machine's power cables, light cable and door micro-switch cable (5/10/15/20m);
- Voltage monitor for three-phase application;
- Cataphoresis treatment on evaporator and/or condenser;
- Packaging with wooden cage;

800 series wall monoblock dimensions

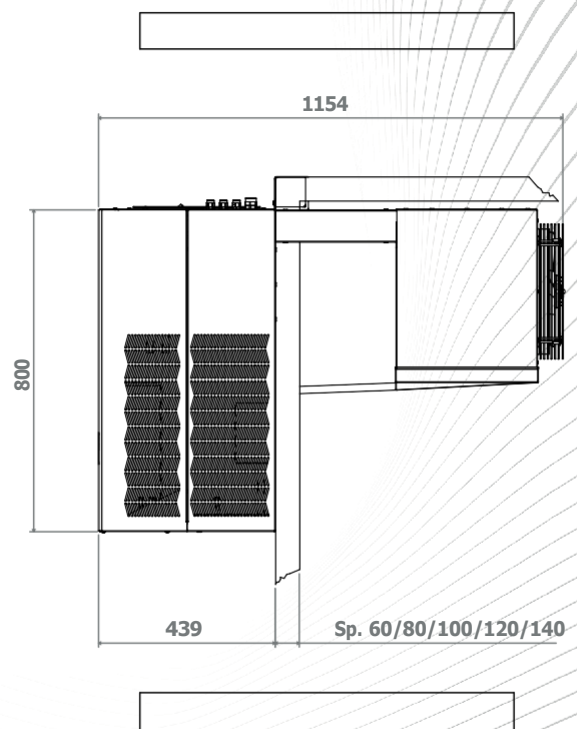
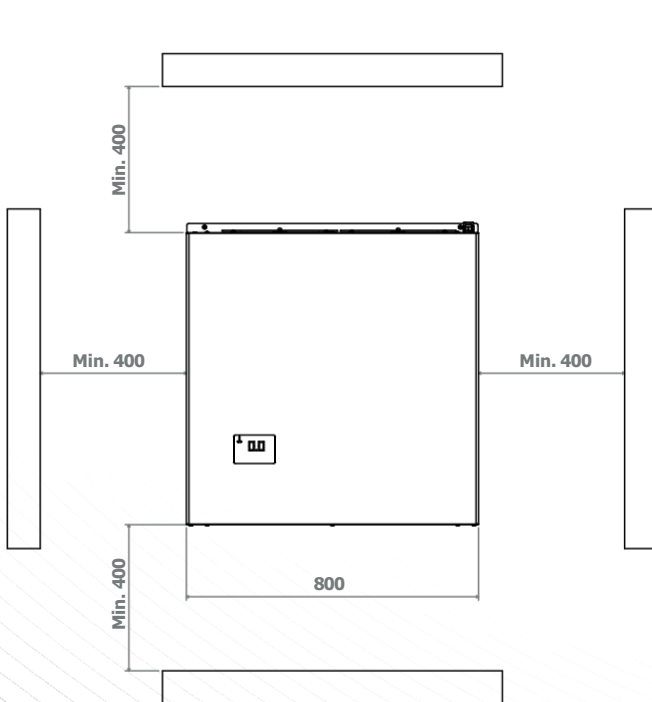
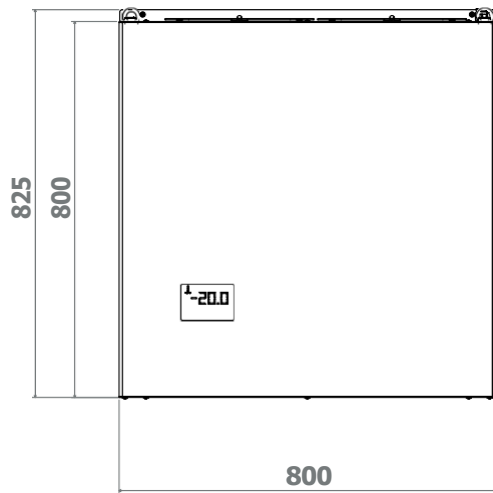

Wall monoblock “SADDLE” version (STANDARD) 800 series



Holes *size in the* cold room panel

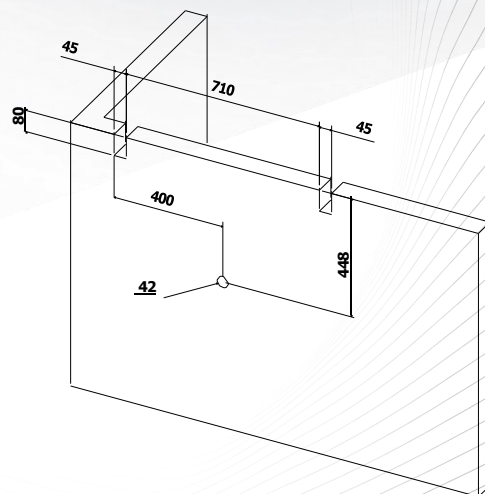
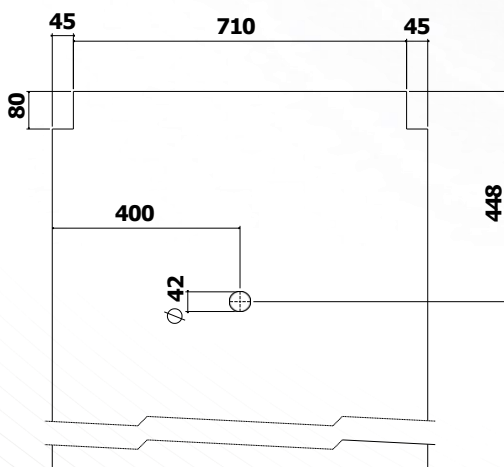

Wall monoblock “PLUG-IN” version (OPTIONAL) 800 series



Hole size in the cold room wall

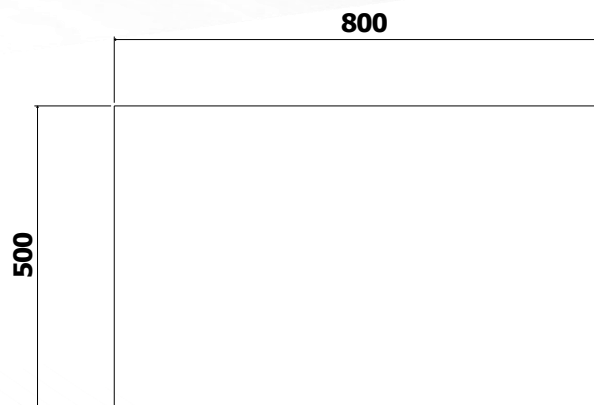

Wall monoblock “PLUG-IN PANEL WITH HOOKS” version (OPTIONAL) 800 series



Panel with hooks dimensions

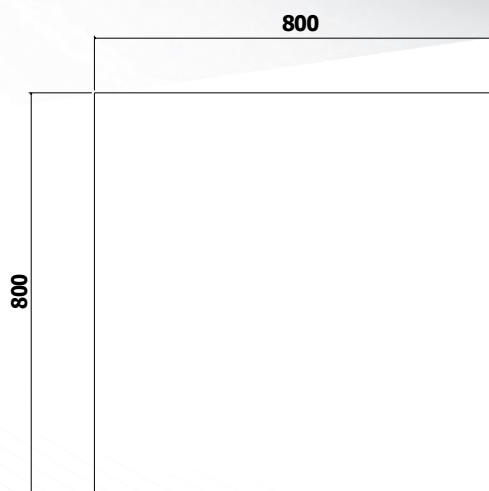

Packaging *dimensions for wall monoblock*

